

Pneumatically Controlled, On-Off Deluge Valve

Model: FP 400E-4D



UL LISTED

Typical Applications

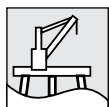

Offshore installations

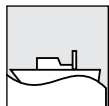

Marine environments

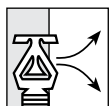

Self contained dry systems



Freezing environments



Sea water/corrosive water supplies

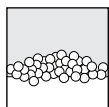

Foam applications

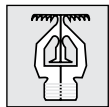

Single interlock pre-action

Features and Benefits

- **Pneumatic PORV** – Best suited for corrosive and freezing conditions
- **Remote reset** – Shut-off on remote command
- **One-piece molded elastomeric moving part** – No maintenance required
- **Simple design** – Cost effective
- **Obstacle-free full bore** – Uncompromising reliability
- **Factory pre-assembled trim** – Out-of-box quality
- **In-line serviceable** – Minimal down time

Optional Features

- **Alarm pressure-switch** (option code: P or P7)
- **Seawater service** (add FS as prefix to model)
- **Valve Position Single/Double Limit Switches**

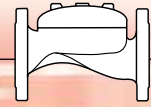

Operation

The BERMAD Model FP 400E-4D is suitable for systems that include dry pilot lines with pneumatic closed fusible plugs (thermal releases), and piping systems with a wide variety of open nozzles. Being pneumatically controlled, the Model FP 400E-4D is recommended in freezing environments and/or with corrosive water supply.

In the SET position the line-pressure, which is supplied to the main valve's control chamber [1] through the priming line [2], a Check Valve [3] and an Accelerator [4] with priming restriction, is trapped by the Check Valve, by a Pneumatic Pressure Operated Relief Valve (PORV) [5], held closed, and by a closed Manual Emergency Release [6]. The trapped pressure holds the main valve's diaphragm and plug against the valve seat [7], sealing it drip-tight and keeping the system piping dry. The PORV is held closed by the maintained pneumatic pressure in the detection dry pilot line.

Under FIRE or TEST conditions, a pilot line pneumatic pressure drop, opens the PORV causing water to exit through the Accelerator faster than it can be supplied. Pressure is then released from the main valve control chamber through the opened PORV, or the Manual Emergency Release, allowing the main valve to fully open and water to flow into the system piping and to the alarm device (if mounted).

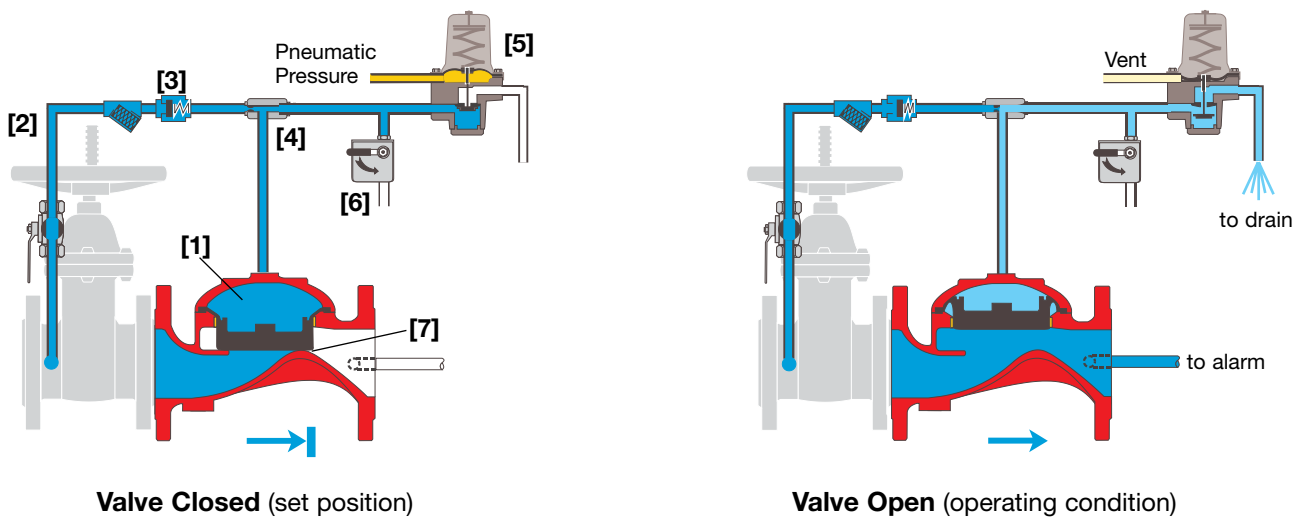

Engineer Specifications

- The On-Off deluge valve shall be a UL-Listed, pneumatically controlled, elastomeric type globe valve with a **rolling-diaphragm**.
- The valve shall have an **unobstructed flow path**, with no stem guide or **supporting ribs**.
- Valve actuation shall be accomplished by a fully peripherally supported, one-piece balanced rolling-diaphragm, vulcanized with a rugged radial seal disk. The diaphragm assembly shall be the only moving part.
- The valve shall have a removable cover for quick in-line service enabling all necessary inspection and servicing.
- The control trim materials shall be S.S.316 tubing and fittings and plated brass accessories, including Y strainer, Accelerator, Pressure-Operated Relief Valve, and Manual Emergency Release.
- The control trim shall be supplied as an assembly, pre-assembled and hydraulically tested at an ISO 9000 and 9001 certified factory.
- The pneumatically controlled, On-Off deluge valve shall open in response to pilot line pneumatic pressure drop.

BERMAD Fire Protection

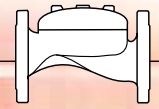

Model: FP 400E-4D

400 Series

System Components

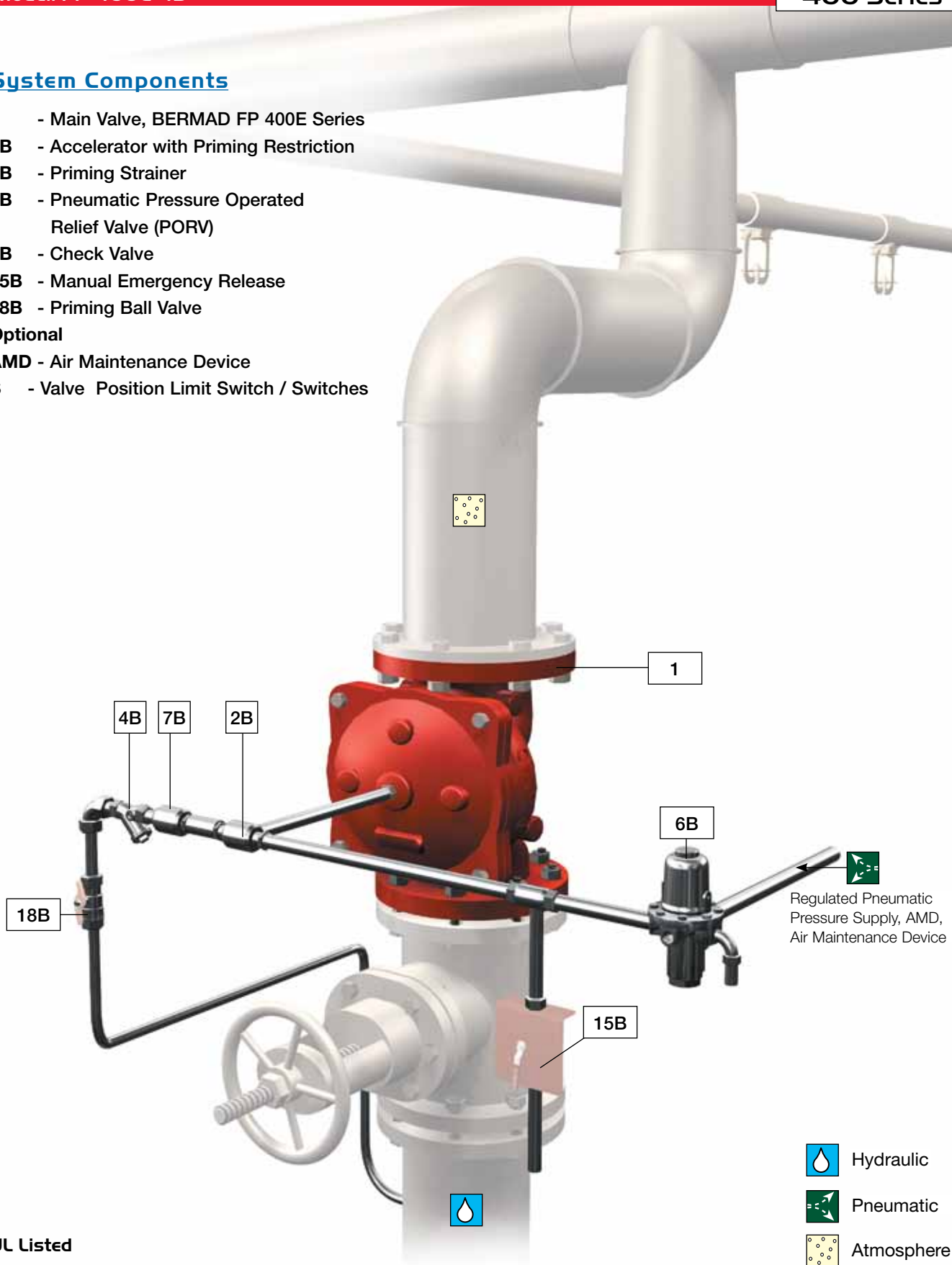

- 1 - Main Valve, BERMAD FP 400E Series
 - 2B - Accelerator with Priming Restriction
 - 4B - Priming Strainer
 - 6B - Pneumatic Pressure Operated Relief Valve (PORV)
 - 7B - Check Valve
 - 15B - Manual Emergency Release
 - 18B - Priming Ball Valve
- Optional**
- AMD - Air Maintenance Device
 - S - Valve Position Limit Switch / Switches



UL Listed

The BERMAD Model FP 400E-4D is UL-Listed.

The installation shall include Indicating and Drain Components.

-  Hydraulic
-  Pneumatic
-  Atmosphere

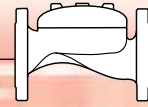

Technical Data

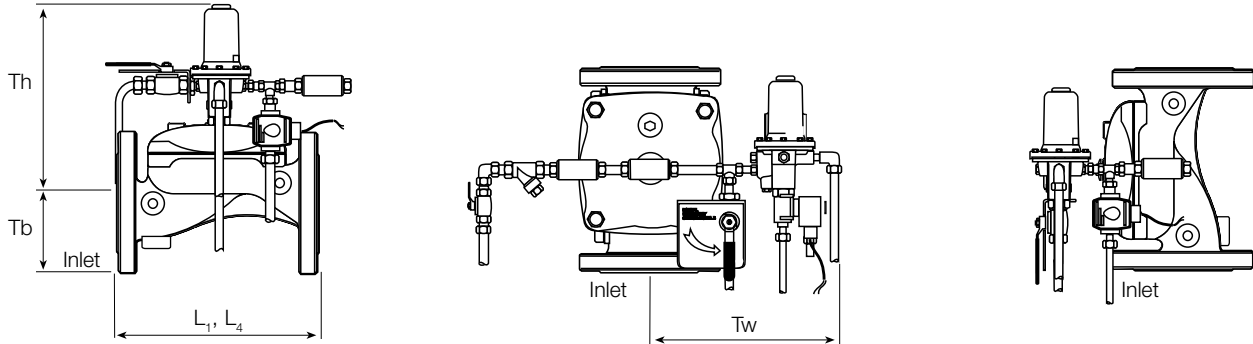

Size	1½"		2"		2½"		3"		4"		6"		8"		10"		12"		
	mm	inch	mm	inch	mm	inch	mm	inch	mm	inch	mm	inch	mm	inch	mm	inch	mm	inch	
Dimensions	L ₁ ⁽¹⁾	205	8 ¹ / ₁₆	205	8 ¹ / ₁₆	205	8 ¹ / ₁₆	257	10 ² / ₁₆	320	12 ¹⁰ / ₁₆	415	16 ⁵ / ₁₆	500	19 ¹¹ / ₁₆	607	23 ¹⁴ / ₁₆	725	28 ⁹ / ₁₆
	L ₄ ⁽²⁾	205	8 ¹ / ₁₆	205	8 ¹ / ₁₆	N/A	N/A	257	10 ² / ₁₆	320	12 ¹⁰ / ₁₆	N/A	N/A	500	19 ¹¹ / ₁₆	N/A	N/A	N/A	N/A
	Tw	255	10 ¹ / ₁₆	255	10 ¹ / ₁₆	255	10 ¹ / ₁₆	255	10 ¹ / ₁₆	255	10 ¹ / ₁₆	255	10 ¹ / ₁₆	255	10 ¹ / ₁₆	255	10 ¹ / ₁₆	255	10 ¹ / ₁₆
	Tb	64	2 ⁸ / ₁₆	78	3 ¹ / ₁₆	89	3 ⁸ / ₁₆	100	3 ¹⁵ / ₁₆	115	4 ⁸ / ₁₆	140	5 ⁸ / ₁₆	172	6 ¹² / ₁₆	204	8 ¹ / ₁₆	242	9 ⁸ / ₁₆
	Th	289	11 ⁶ / ₁₆	289	11 ⁶ / ₁₆	301	11 ¹⁴ / ₁₆	325	12 ¹³ / ₁₆	345	13 ⁹ / ₁₆	420	16 ⁹ / ₁₆	471	18 ⁹ / ₁₆	471	18 ⁹ / ₁₆	588	23 ² / ₁₆

- Notes:**
- L₁ is for flanged ANSI #150 and ISO PN16.
 - L₄ is for grooved end connections (Ductile Iron Only).
 - Provide adequate space around valve for maintenance.
 - Data is for envelope dimensions, specific component positioning may vary.

Connection Standard

- Flanged: ANSI B16.42 (Ductile Iron), B16.5 (Steel & Stainless Steel), B16.24 (Bronze)
- ISO PN16
- Grooved: ANSI/AWWA C606 for 2, 3, 4, 6 & 8"

Water Temperature

- 0.5 – 50°C (33 – 122°F)

Available Sizes

- 1½, 2, 2½, 3, 4, 6, 8, 10 & 12"
- UL-Listed for sizes 1½, 2, 2½, 3, 4, 6, 8 & 10"

Pressure Rating

- Max. working pressure: 250 psi (17 bar)

PORV Setting

Valve opens on pilot line pressure drop
factory set: 20 psi (1.5 bar)

Manufacturers Standard Materials

Main valve body and cover

- Ductile Iron ASTM A-536

Main valve internals

- Stainless Steel 304 & Cast Iron

Control Trim System

- Brass control components/accessories
- Stainless Steel 316 tubing & fittings

Elastomers

- Nylon fabric reinforced polyisoprene NR

Coating

- Electrostatic Powder Coating Polyester, Red (RAL 3002)

Optional Materials

Main valve body

- Carbon Steel ASTM A-216 WCB
- Stainless Steel 316
- Ni-Al-Bronze ASTM B-148

Control Trim

- Stainless Steel 316
- Monel) and Al-Bronze
- Hastalloy C-276

Elastomers

- NBR
- EPDM

Coating

- High Build Epoxy Fusion-Bonded with UV Protection, Anti-Corrosion

